

zamek

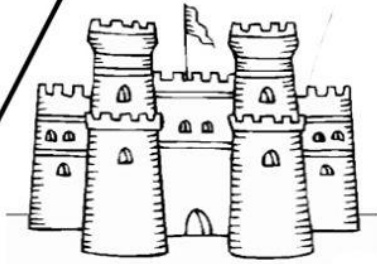

mieszkali w nim
królowie



służy do zapinania
kurtki

pióro



pokrywa ciało ptaków



można nim pisać

GADU
terapia

bokser



rasa psa



osoba uprawiająca
boks

GADU
terapia

pączki



wyrastają z nich kwiaty
lub liście

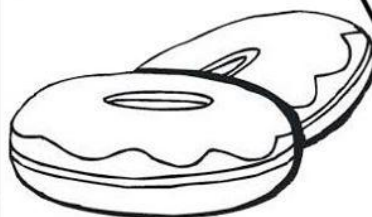

słodkie
wyroby cukiernicze

GADU
terapia

muszka



element męskiej
garderoby

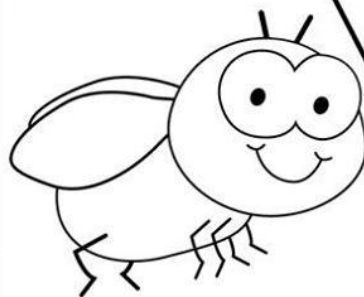

mały owad

myszka

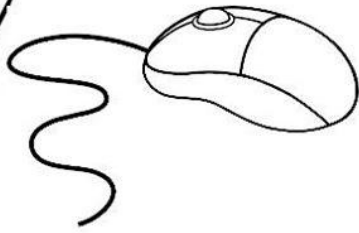

przydatna podczas
korzystania z komputera

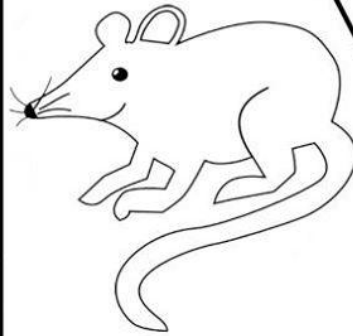

mały ssak

kucyk

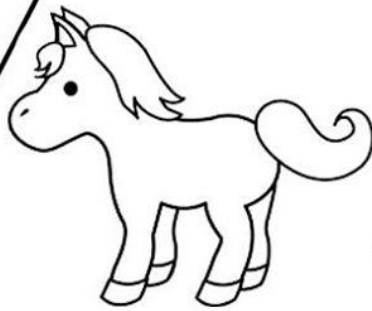

niewielki koń



sposób spięcia włosów

GADU
terapia

granat

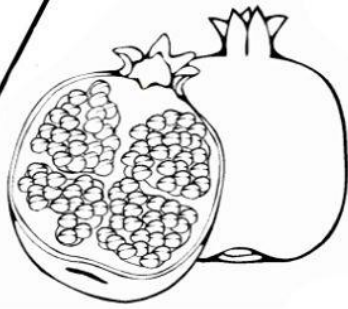

pyszny, soczysty owoc

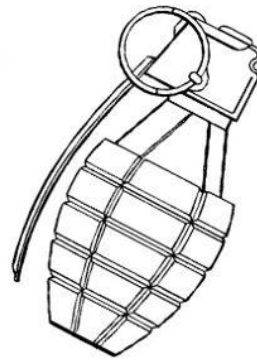

rodzaj broni

kurka



jadalny, żółty grzyb

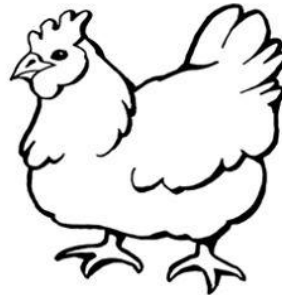

hodowlany ptak

piłka



służy do gry i zabawy

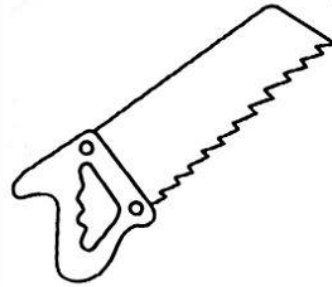

służy do przecinania
np. drewna

koło

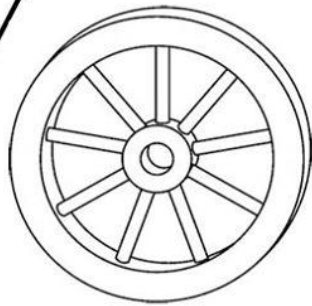

element pojazdu

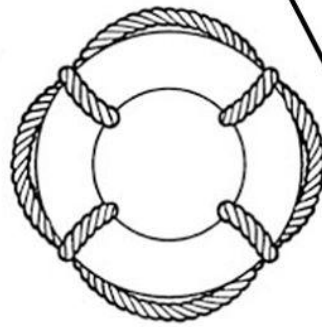

ratunkowe,
np. na basenie

rakieta

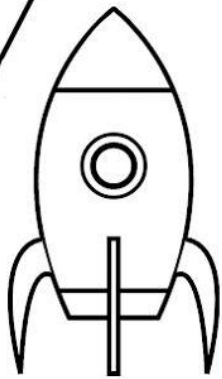

można ją wystuć
w kosmos



służy do gry
w tenisa

ucho



narząd słuchu



służy do trzymania
filizanki

zebra



zwierzę w paski

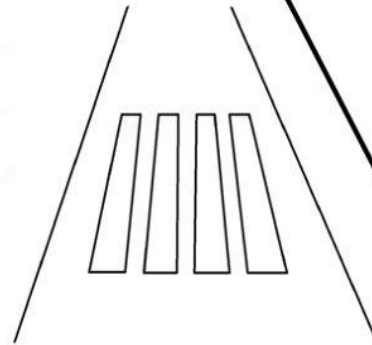

inaczej przejście
dla pieszych

GADU
terapia

para



unoszą się nad gorącą
herbatą



na przykład
dwoje zakochanych

GADU
terapia

kiwi

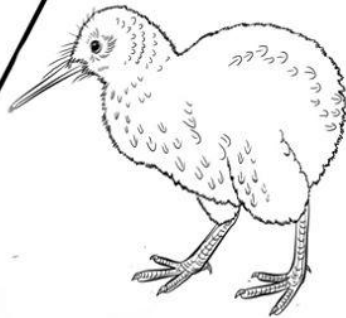

ptak żyjący w Nowej
Zelandii



zielony, pyszny owoc

pilot



służy do włączania
telewizora

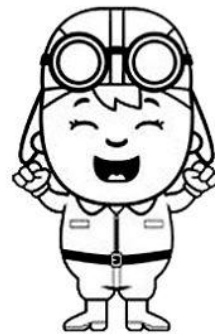

steruje samolotem

GADU
terapia